

02B	SCHEMATIC TIDY CREATED GRID FILE	BENC				
02A	ADDED CONNECTOR PL110	BENC				
REV/ISS	AMENDMENTS	DRAWN	CHKD	D.O.	APVD	DATE

TAIT ELECTRONICS

T858PA CONTROL SECTION

IPN: 220-01423-02 ISSUE: B ID: 2.S.C. 1

PROJECT: T858 DESIGNER: BEN C FILE NAME: 1423_02B FILE DATE: 01-06-99 NO. SHEETS: 3

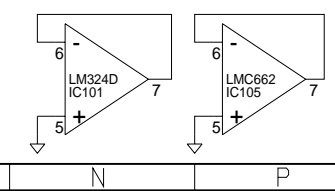

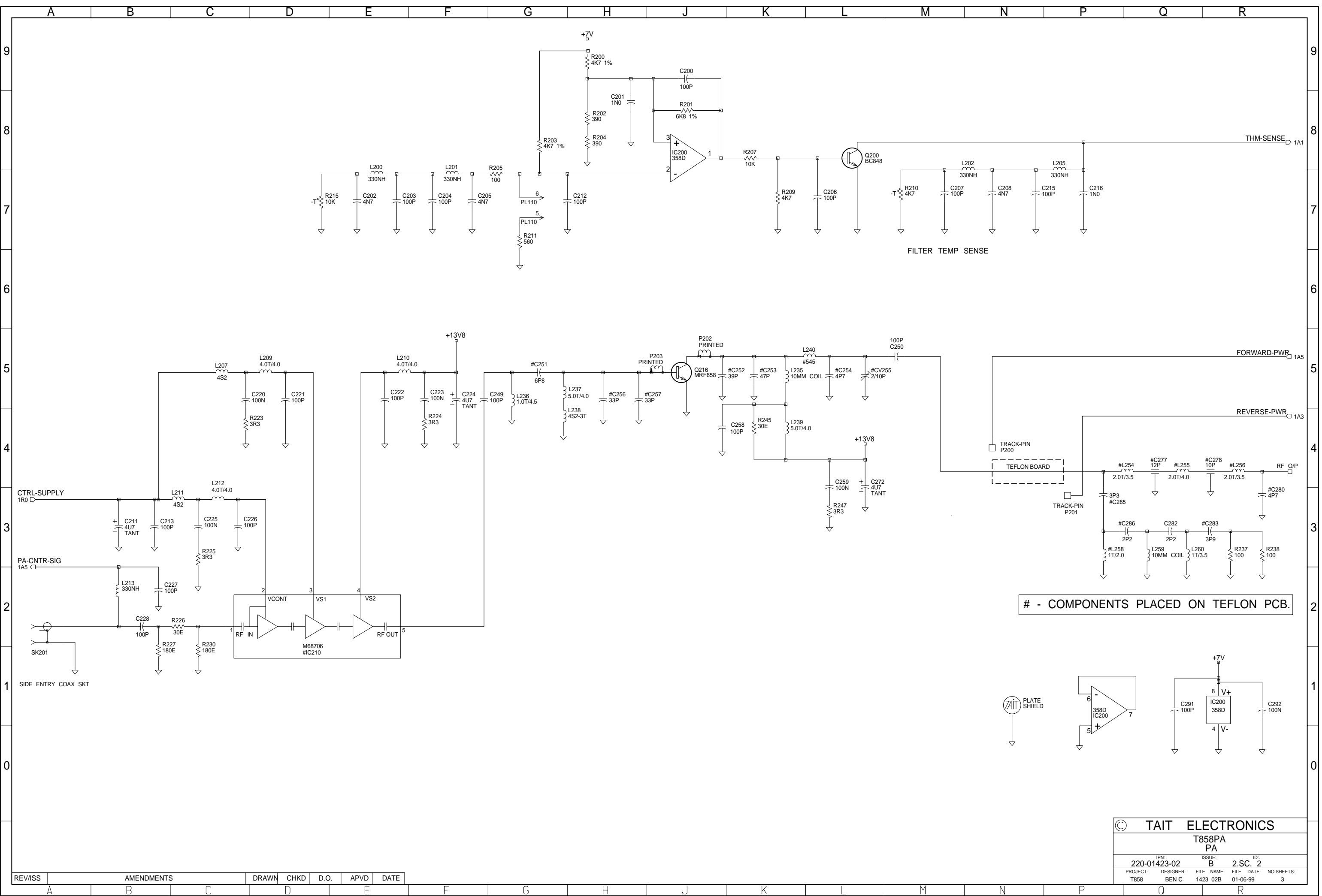



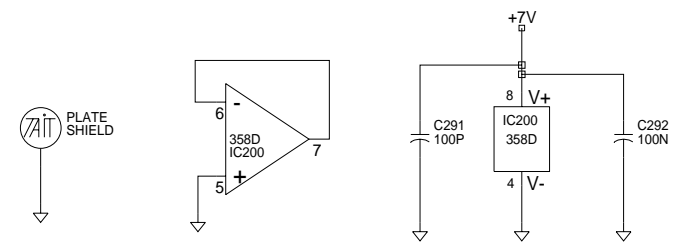

- COMPONENTS PLACED ON TEFLON PCB.



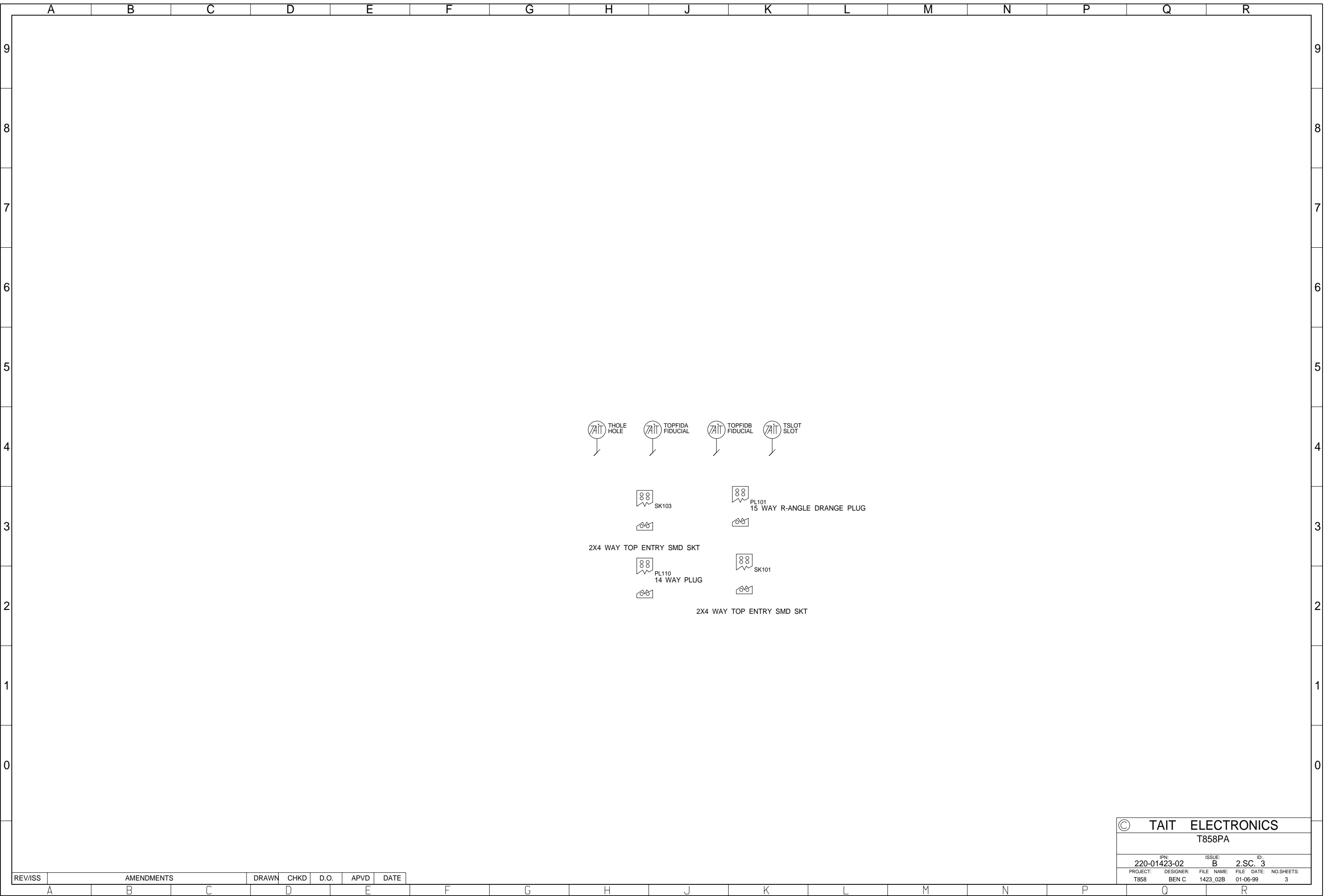



© TAIT ELECTRONICS			
T858PA PA			
IPN: 220-01423-02	ISSUE: B	FILE NAME: 1423_02B	ID: 2.SC. 2
PROJECT: T858	DESIGNER: BEN C	FILE DATE: 01-06-99	NO.SHEETS: 3

REV/ISS	AMENDMENTS	DRAWN	CHKD	D.O.	APVD	DATE
A						







 THOLE HOLE
  TOPFIDA FIDUCIAL
  TOPFIDB FIDUCIAL
  TSLOT SLOT

 SK103

 PL101
 15 WAY R-ANGLE DRANGE PLUG

2X4 WAY TOP ENTRY SMD SKT

 PL110
 14 WAY PLUG

 SK101

2X4 WAY TOP ENTRY SMD SKT

© TAIT ELECTRONICS			
T858PA			
IPN:	ISSUE:	ID:	
220-01423-02	B	2.SC. 3	
PROJECT:	DESIGNER:	FILE NAME:	FILE DATE: NO.SHEETS:
T858	BEN C	1423_02B	01-06-99 3

REV/ISS	AMENDMENTS	DRAWN	CHKD	D.O.	APVD	DATE
A						
B						
C						
D						
E						
F						
G						
H						
J						
K						
L						
M						
N						
P						
Q						
R						

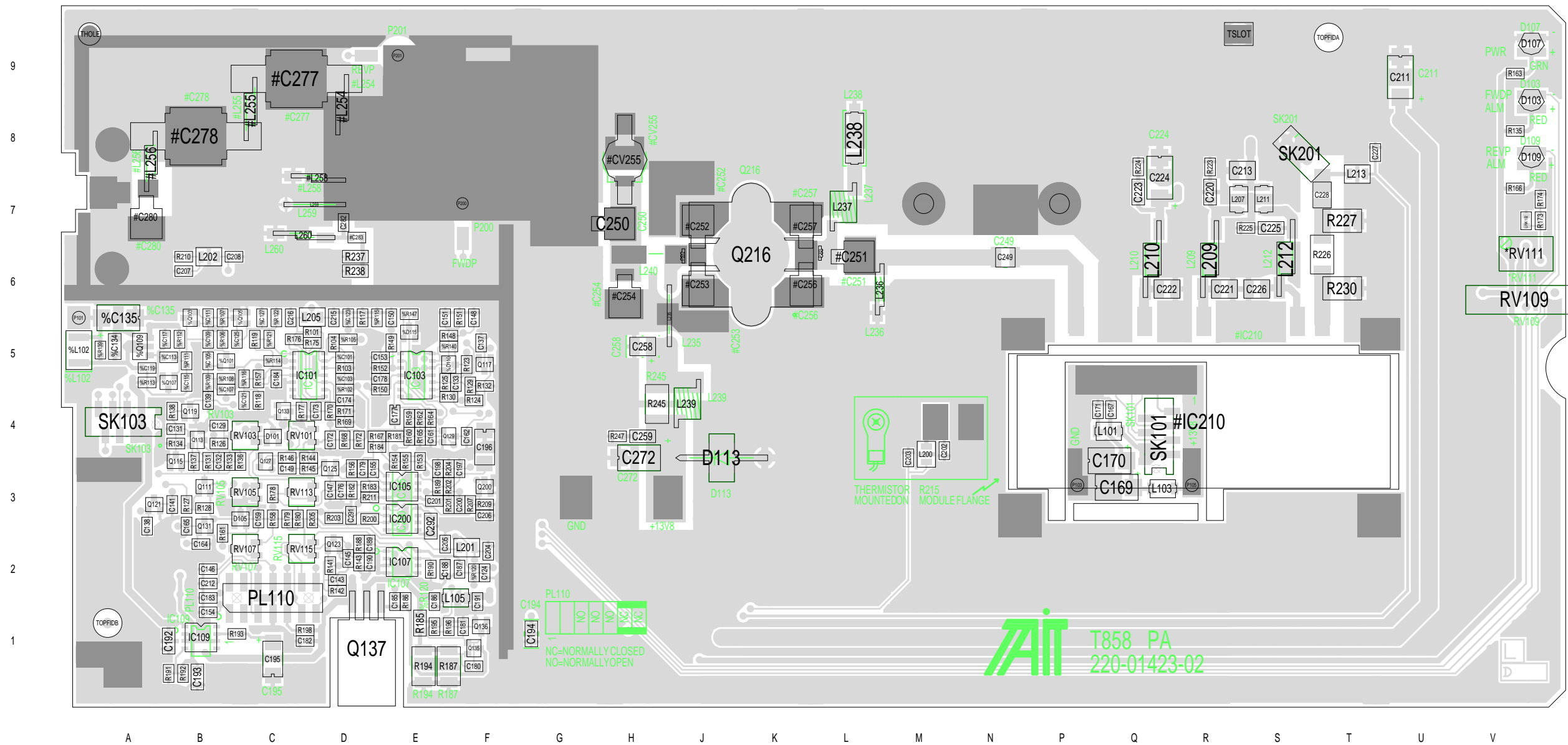

TAIT ELECTRONICS	IPN: 220-01423-02	ISS: 02	ID: 1.TA	DATE: 17 Jun 1999
T858 PA PCB LAYOUT - TOP SIDE				

Scale: 1.2:1 ; Rotation: 0 degrees

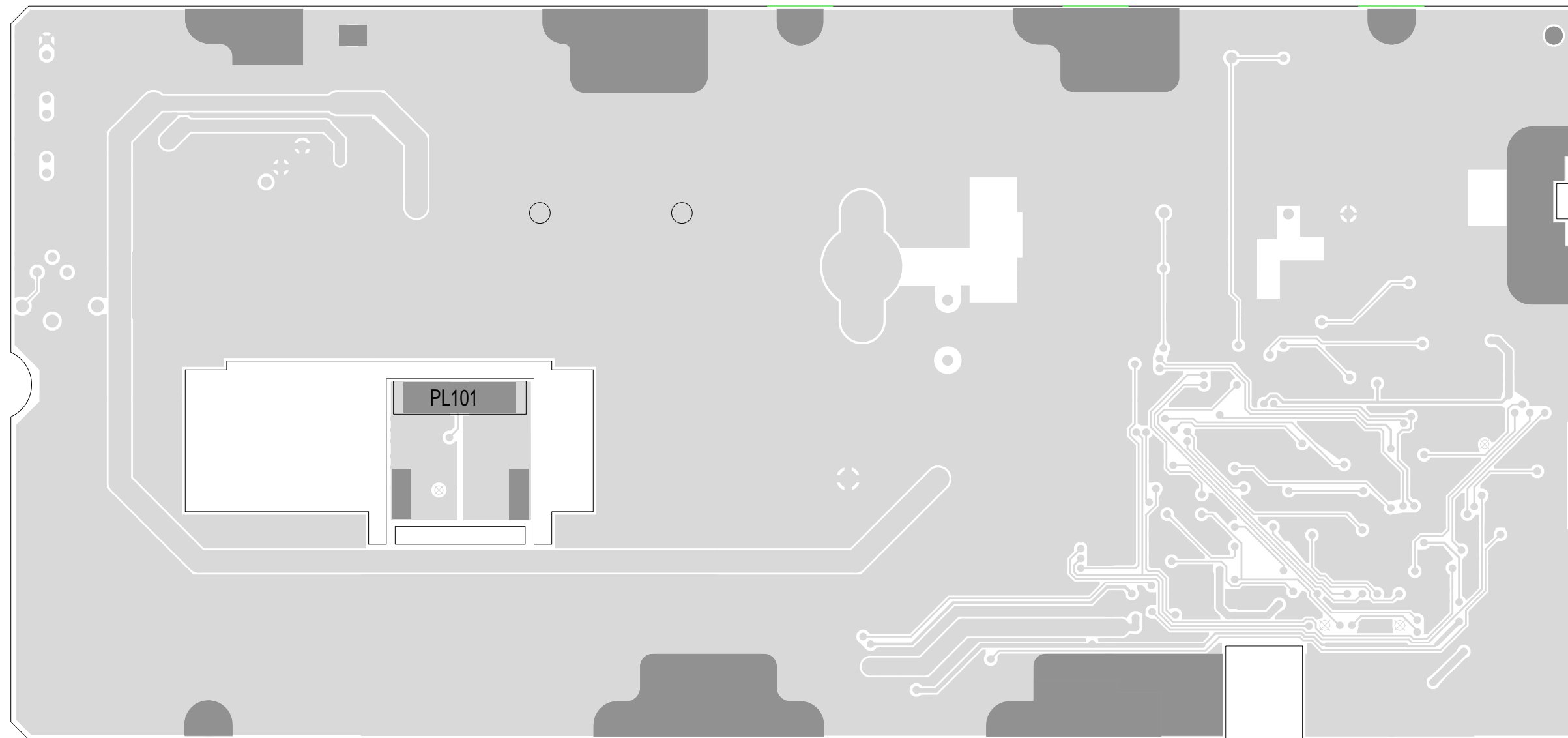

9
8
7
6
5
4
3
2
1

V U T S R Q P N M L K J H G F E D C B A

TAIT ELECTRONICS	IPN: 220-01423-02	ISS: 02	ID: 2.BA	DATE: 17 Jun 1999
T858 PA PCB LAYOUT - BOTTOM SIDE				

Scale: 1.2:1 ; Rotation: 0 degrees